

Otis

Lorenz*Kaz

2007/2008

Tavolo rotondo

Materiali:

BASE: lamiera di acciaio verniciato a polvere color bianco o nero, piedini regolabili.

PIANO: pannello in multistrato di betulla rivestito con laminato HPL color bianco opaco o nero opaco oppure rivestito con superficie nanotecnologica Fenix NTM® nero opaco "soft touch".

+info:
<http://www.depadova.com/materials.pdf>

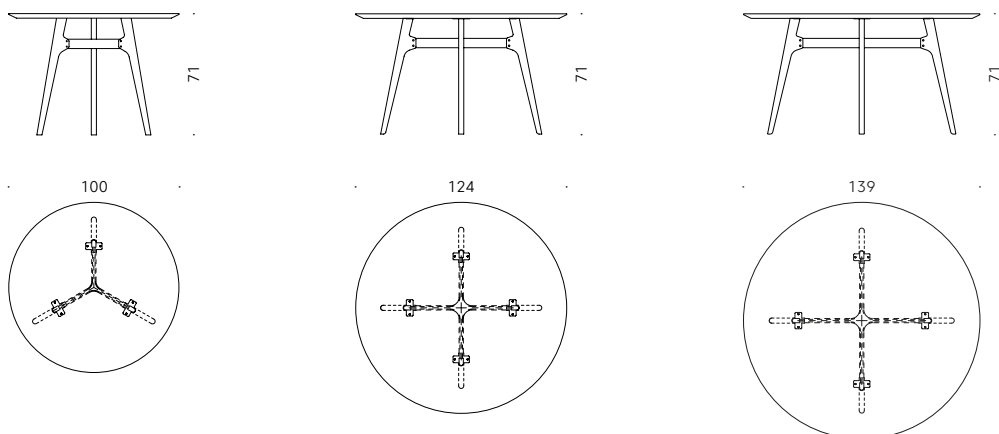

Otis

Lorenz*Kaz

2007/2008

Round table

Materials:

BASE: steel sheet, white or black powder-coated. Adjustable feet.
TOP: plywood birch panel covered with matt white or matt black HPL laminate or with Fenix NTM® nanotechnology surface, matt black 'soft touch'.

+info:
<http://www.depadova.com/materials.pdf>

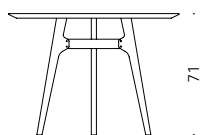

100

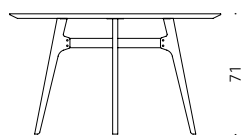
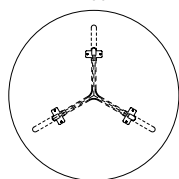

124

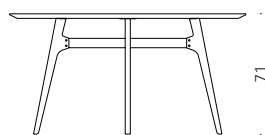
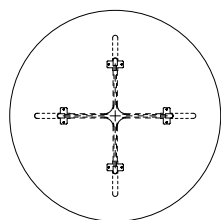

139

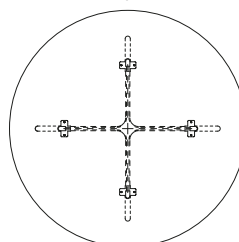

Otis Lorenz*Kaz 2007/2008

Table ronde

Matériaux:

BASE: tôle en acier peint blanc ou noir à poudre, pieds réglables.
DESSUS: panneau de multiplis de bouleau, revêtu avec stratifié HPL blanc mat ou noir mat ou revêtu avec surface nanotechnologique Fenix NTM® noir mat "soft touch".

+info:
<http://www.depadova.com/materials.pdf>

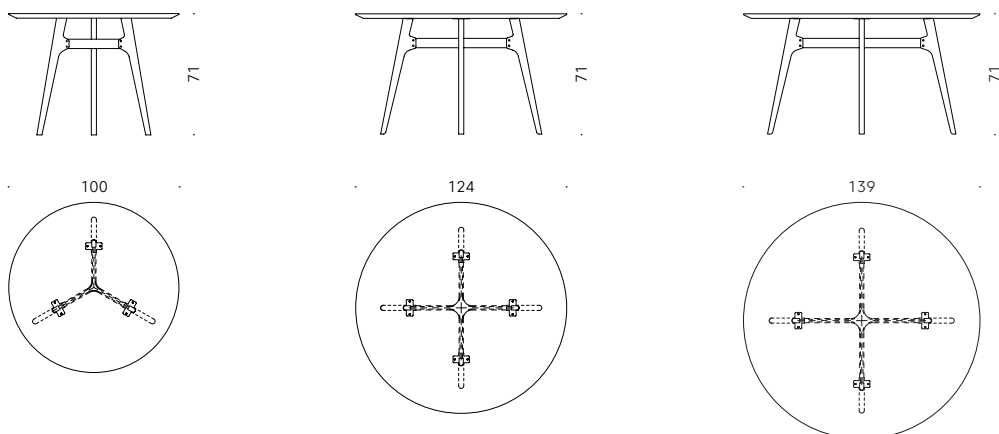

Otis

Lorenz*Kaz

2007/2008

Runder Tisch

Materialien:

GESTELL: Stahlblech mit Pulverlackierung, weiß oder schwarz. Verstellbare Füße.

TISCHPLATTE: Paneel in Birkenchichtholz, verkleidet mit Laminat HPL matt weiß oder matt schwarz oder mit matt schwarzer nanotechnologischer Oberfläche Fenix NTM® „Soft Touch“.

+info:
<http://www.depadova.com/materials.pdf>

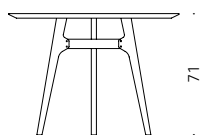

100

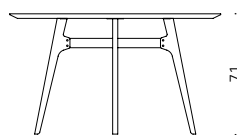
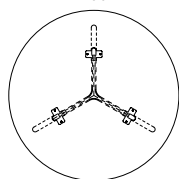

124

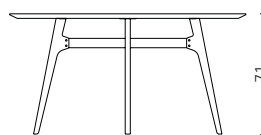
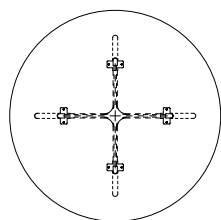

139

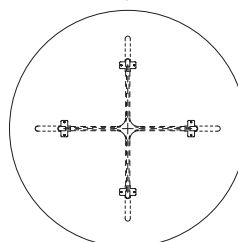

Otis

Lorenz*Kaz

2007/2008

Mesa redonda

Materiales:

BASE: chapa de acero pintado en polvo color blanco o negro, pies ajustables.

TABLERO: panel de multicapa de abedul revestido en laminado HPL color blanco mate o negro mate o revestido en superficie nanotecnológica Fenix NTM® negro mate "soft touch".

+info:

<http://www.depadova.com/materials.pdf>

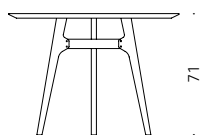

100

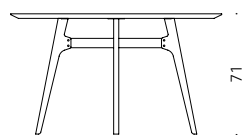
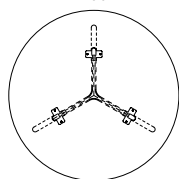

124

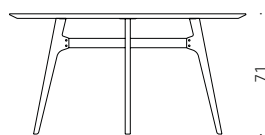
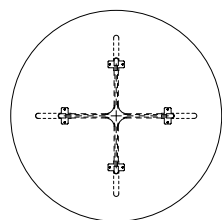

139

