

## SC16 2016



### Sistema di contenitori

#### Materiali:

**CONTENITORE:** pannelli di listellare impiallacciati in Abonos fossil oak o rovere affumicato, finiti con vernice trasparente a base acqua o a base solvente. Bordo a 45° in legno massello di Abonos fossil oak o rovere affumicato.

**CASSETTI:** listellare impiallacciato in Abonos fossil oak o rovere affumicato, finiti con vernice trasparente a base acqua o a base solvente, montati su guide con meccanismo di ammortizzazione.  
**FRONTALI CASSETTI:** listellare impiallacciato in Abonos fossil oak o rovere affumicato, finiti con vernice trasparente a base acqua o a base solvente. Oppure in lamiera in ottone striato, acciaio striato grigio o acciaio délabré scuro. Bordo a 45° e maniglia in massello di essenza.

**PIANO:** listellare impiallacciato con Abonos fossil oak o rovere affumicato, finiti con vernice trasparente a base acqua o a base solvente. Oppure pannello interno in alluminio strutturale rivestito con lamiera in ottone striato, acciaio striato grigio o acciaio délabré scuro. Oppure marmo Grey Stone o bianco Carrara o Calacatta Oro, finito a mano e trattato con prodotti idrorepellenti. Rinforzo inferiore con rete di fibra di vetro annegata con resine epossidiche.

**BASE:** acciaio verniciato a polvere nero opaco e piede in acciaio brunito. Sottopiede regolabile in termoplastica.

**PIEDINI:** acciaio brunito. Sottopiede regolabile in termoplastica.

+info:  
<http://www.depadova.com/materials.pdf>

Contenitori con piedini.

M75

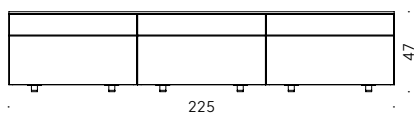
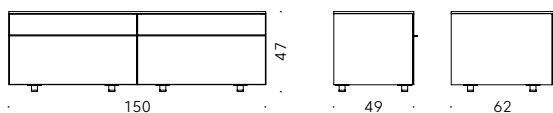

M90

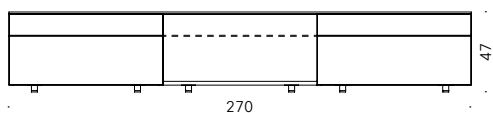
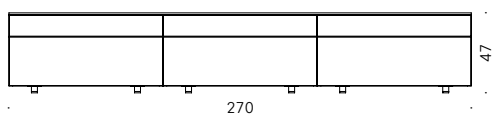
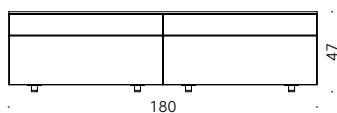

M120

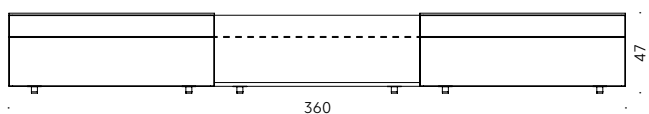
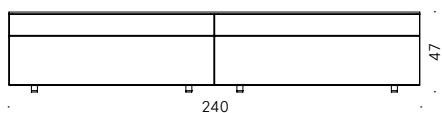

Contenitori con base.

M75

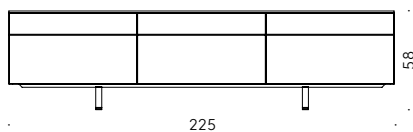
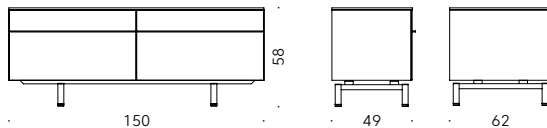

M90

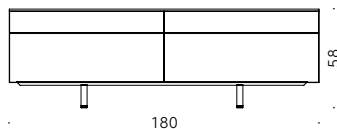

M120

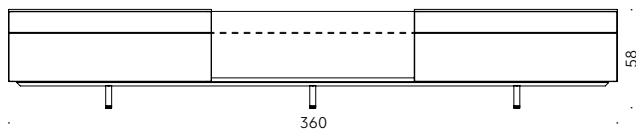
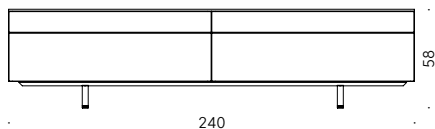
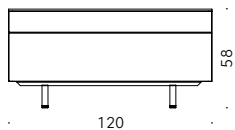

## SC16 2016



### Storage unit system

**Materials:**

CARCASS: blockboard panels veneered in Abonos fossil oak or smoked oak, finished with transparent water-based or solvent-based coating. 45° edges in solid wood (Abonos fossil oak or smoked oak).

DRAWERS: blockboard, veneered in Abonos fossil oak or smoked oak, finished with transparent water-based or solvent-based coating. Installed on runners with soft-close system.

DRAWER FRONT PANELS: blockboard veneered in Abonos fossil oak or smoked oak, finished with transparent water-based or solvent-based coating. Or in sheet in striped brass, grey striped steel or dark délabré steel. 45° edge and handle in solid wood.

TOP: blockboard veneered in Abonos fossil oak or smoked oak, finished with transparent water-based or solvent-based coating. Or internal panel in structural aluminium covered by sheet in striped brass, grey striped steel or dark délabré steel. Or in Grey Stone marble, white Carrara marble or Calacatta Oro, hand finished and treated with water repellent products. Lower reinforcement made of fiberglass mesh, embedded in epoxy resins.

BASE: matt black powder-coated steel and feet in burnished steel. Adjustable thermoplastic glide foot.

FEET: burnished steel. Adjustable thermoplastic glide foot.

+info:

<http://www.depadova.com/materials.pdf>

Cabinets with feet.

M75

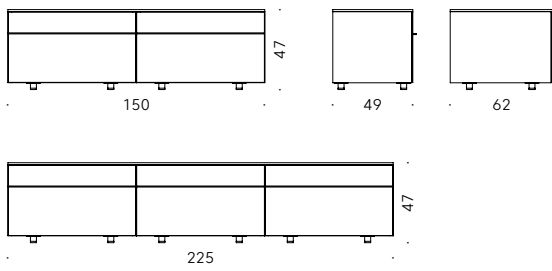

M90

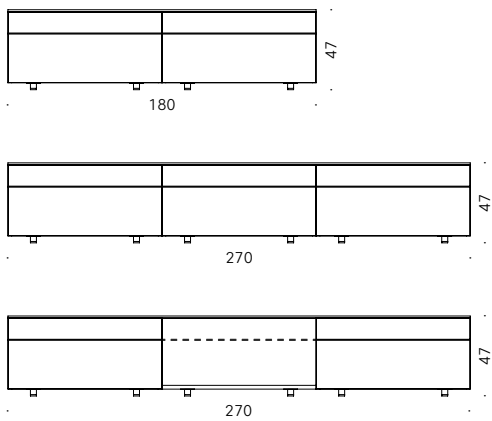

M120

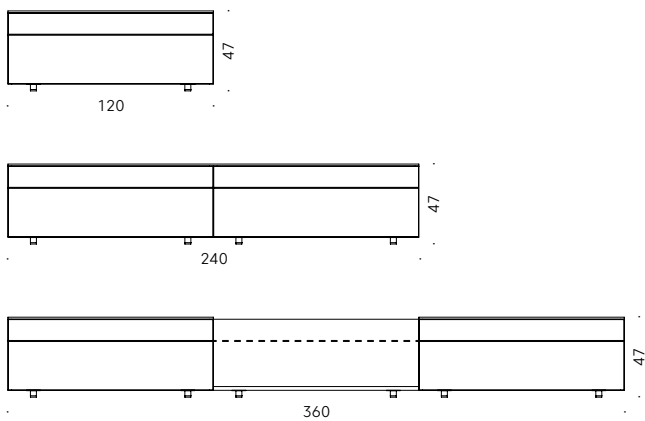

Cabinets with base.

M75

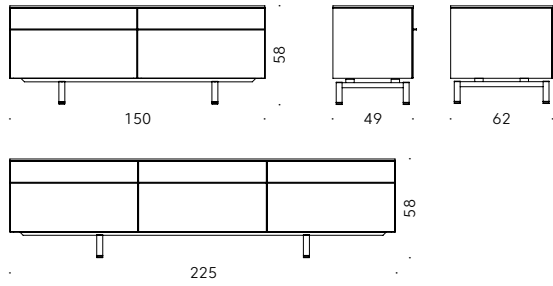

M90

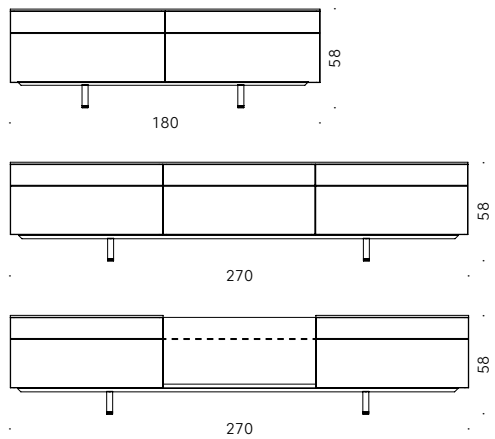

M120

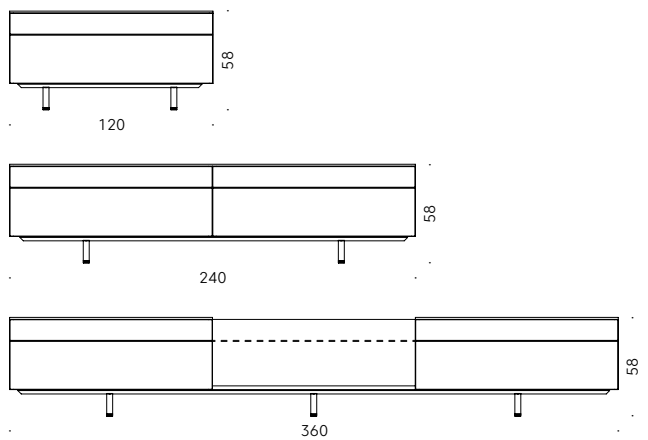

## SC16 2016



### Système de rangement

#### Matériaux:

ELEMENT DE RANGEMENT: panneaux de latté plaqués en Abonos fossil oak ou chêne fumé, finis avec peinture transparente à l'eau ou à base de solvant. Chant à 45° en bois massif de Abonos fossil oak ou chêne fumé.

TIROIRS: latté plaqué en Abonos fossil oak ou chêne fumé, finis avec peinture transparente à l'eau ou à base de solvant, montés sur glissières avec mécanisme d'amortissement.

FACADES TIROIRS : latté plaqué en Abonos fossil oak ou chêne fumé, finis avec peinture transparente à base d'eau ou à base de solvant. Ou en tôle en laiton strié, acier strié gris ou acier délabré foncé. Chant à 45° et poignée en massif d'essence.

DESSUS: latté plaqué avec Abonos fossil oak ou chêne fumé, finis avec peinture transparent à l'eau ou à base de solvant. Ou panneau interne en aluminium structurel revêtu avec tôle en laiton strié, acier strié gris ou acier délabré foncé. Ou Marbre Grey Stone ou blanc Carrara ou Calacatta Oro, fini à la main et traité avec des produits hydrofuges. Renfort inférieur avec grillage en fibre de verre noyée avec des résines époxy.

BASE: acier peint à poudre noir mat et pied en acier bruni. Patin réglable en thermoplastique.

PIEDS: acier bruni. Patin réglable en thermoplastique.

+info:  
<http://www.depadova.com/materials.pdf>

Éléments de rangement avec pieds.

M75

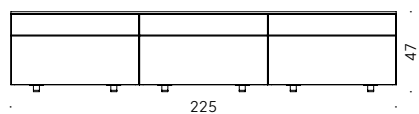
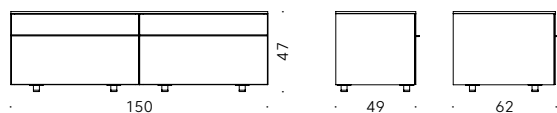

M90

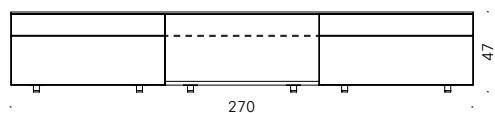
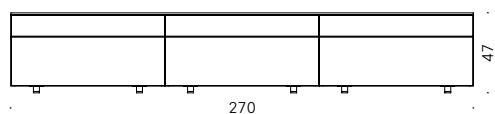
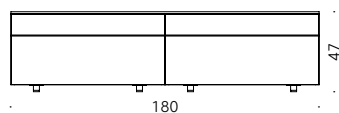

M120

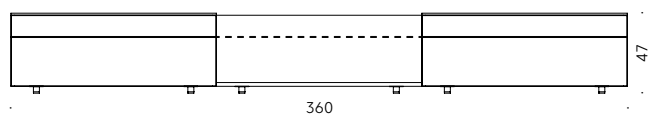
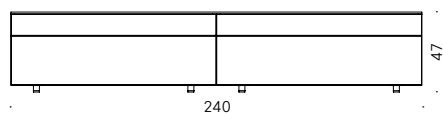

Éléments de rangement avec base.

M75

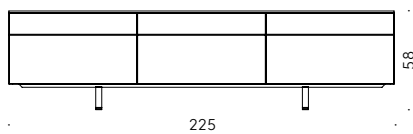
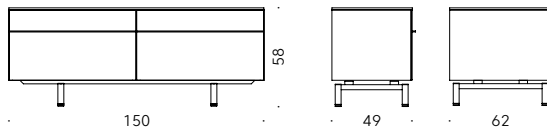

M90

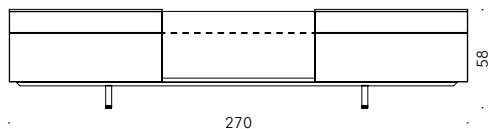
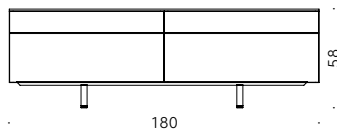

M120

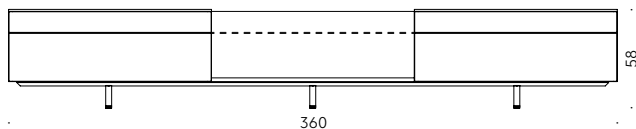
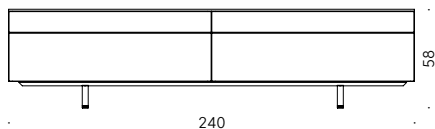
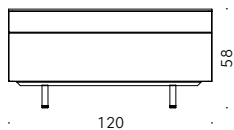

## SC16 2016



### Schranksystem

#### Materialien:

**KORPUS:** Tischlerplatten, furniert in Abonos fossil oak oder Räumereiche, endbehandelt mit transparentem Lack auf Wasser- oder Lösemittelbasis. Ecke 45° aus Massivholz Abonos fossil oak oder Räumereiche.

**SCHUBLADEN:** Tischlerplatte, furniert in Abonos fossil oak oder Räumereiche, endbehandelt mit transparentem Lack auf Wasser- oder Lösemittelbasis. Montiert auf Führungsschienen mit Einzugsdämpfer.

**SCHUBLADENFRONTEN:** Tischlerplatten, furniert in Abonos fossil oak oder Räumereiche, endbehandelt mit transparentem Lack auf Wasser- oder Lösemittelbasis. Oder hergestellt aus Blech in Messing gestreift, Stahl gestreift grau oder Stahl délabré dunkel. Ecke 45° und Griffe aus Massivholz.

**PLATTE:** Tischlerplatte, furniert in Abonos fossil Oak oder Räumereiche, endbehandelt mit transparentem Lack auf Wasser- oder Lösemittelbasis. Oder Innenpaneel in Strukturaluminium mit Blech in Messing gestreift, Stahl gestreift grau oder Stahl délabré dunkel. Oder Marmor Grey Stone oder weißer Carrara-Marmor oder Marmor Calacatta Oro, von Hand endbehandelt und mit einer wasserabweisenden Schicht versehen. Untere Verstärkung aus epoxidharzgetränktem Glasfasergewebe.

**GESTELL:** Pulverlackiertes Stahlgestell mattschwarz und Fuß aus brüniertem Stahl. Verstellbarer Thermoplast-Gleitfuß.

**FÜßE:** aus brüniertem Stahl. Verstellbarer Thermoplast-Gleitfuß.

+info:  
<http://www.depadova.com/materials.pdf>

Schränkelement mit Füßen.

M75

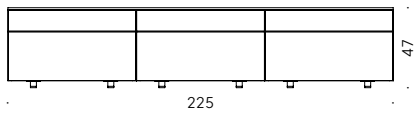
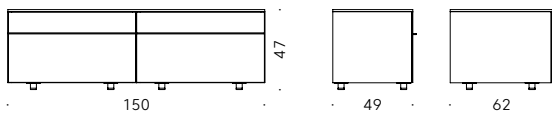

M90

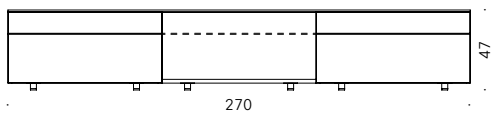
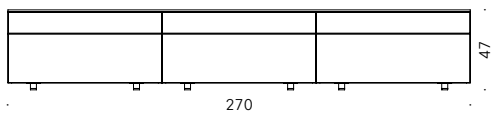
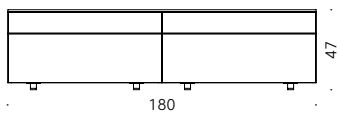

M120

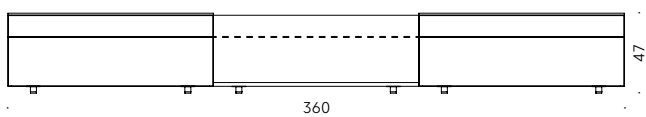
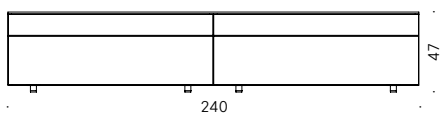
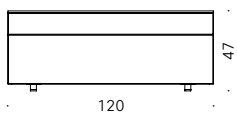

Schränkelement mit Gestell.

M75

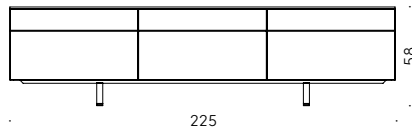
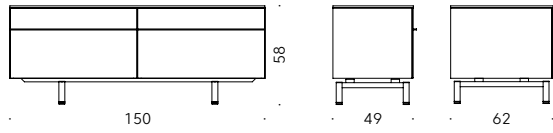

M90

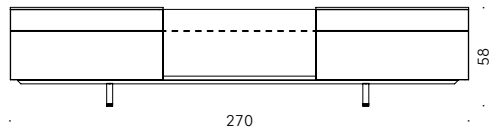
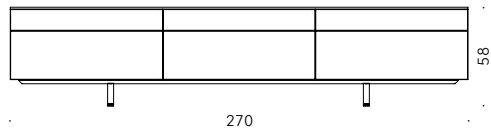
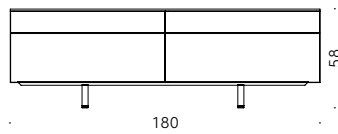

M120

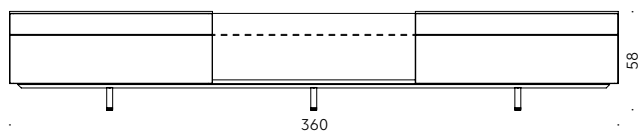
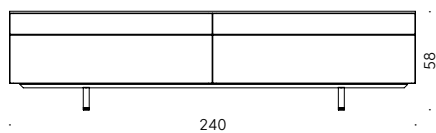
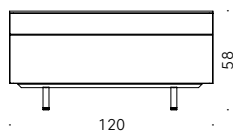



## SC16 2016



### Sistema de muebles contenedores

#### **Materiales:**

**CONTENEDOR:** paneles de madera alistonada chapados en Abonos fossil oak o roble ahumado, acabados con pintura transparente al agua o al disolvente. Borde en 45° de madera maciza de Abonos fossil oak o roble ahumado.

**CAJONES:** madera alistonada de Abonos fossil oak o roble ahumado, acabados con barniz transparente al agua o al disolvente, montados sobre guías con mecanismo de amortiguación.

**FRENTES CAJONES:** madera alistonada chapada con Abonos fossil oak o roble ahumado, acabados con pintura transparente al agua o al disolvente. O de chapa de latón estriado, acero estriado gris o acero envejecido oscuro. Borde en 45° y tirador de madera maciza.

**TABLEOS SUPERIORES:** madera alistonada chapada con Abonos fossil oak o roble ahumado, acabados con pintura transparente al agua o al disolvente. O panel interior de aluminio estructural revestido con chapa de latón estriado, acero estriado gris o acero envejecido oscuro. O mármol Grey Stone o blanco Carrara o Calacatta Oro, acabado a mano y tratado con productos repelentes al agua. Refuerzo inferior con red de fibra de vidrio ahogada con resinas epoxídicas.

**BASE:** acero pintado en polvo negro mate y pie de acero bruñido. Bajo-pie ajustable de termoplástico.

**PIES:** acero bruñido. Bajo-pie ajustable de termoplástico.

+info:  
<http://www.depadova.com/materials.pdf>

Muebles contenedores con pies.

M75

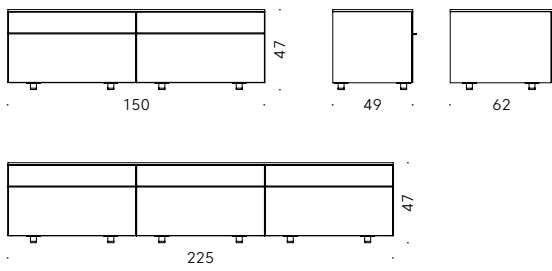

M90

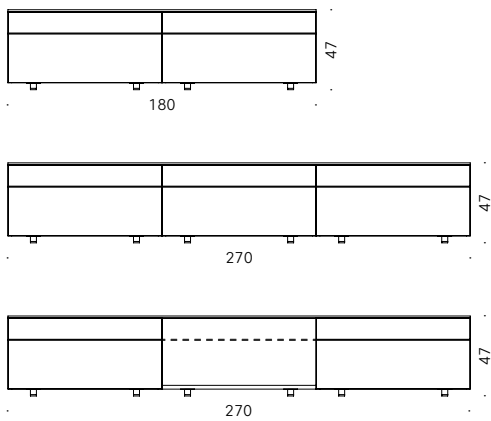

M120

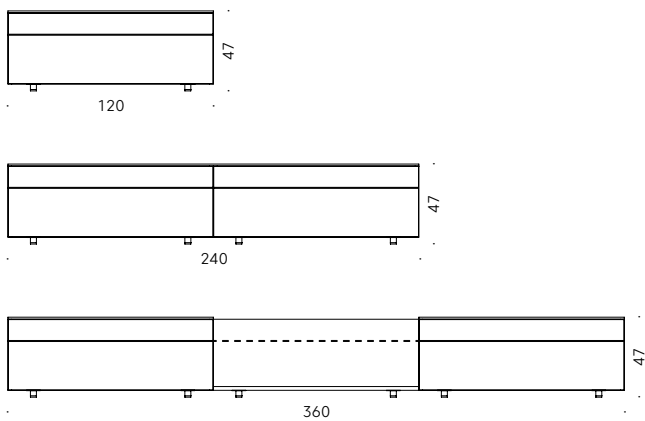

Muebles contenedores con base.

M75

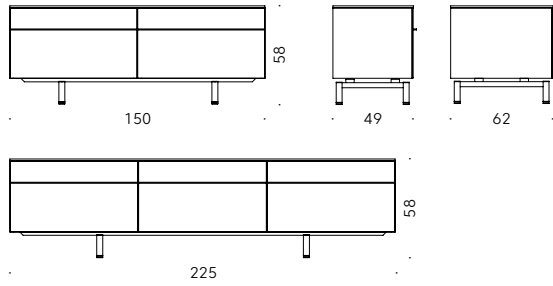

M90

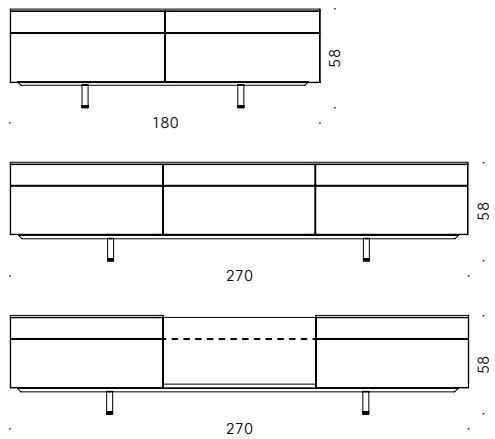

M120

