

Shadow

Vincent Van Duysen

2011



Tavolo

Materiali

STRUTTURA INTERNA: acciaio verniciato a polvere.

BASE/PIANO: finitura bicolore. Piano e lati esterni delle gambe in laminato HPL stratificato impiallacciato in legno Ecowood Xilo 2.0 planked grey (18.23), finito con vernice trasparente a base acqua o a base solvente. Lati interni delle gambe e fasce sotto al piano in laminato HPL stratificato impiallacciato in legno Ecowood Xilo 2.0 planked sand (18.22), finito con vernice trasparente a base acqua o a base solvente.

PIEDINI: regolabili in materiale termoplastico.

+info:

<http://www.depadova.com/materials.pdf>

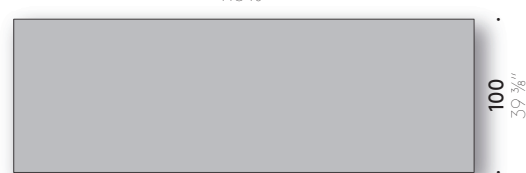
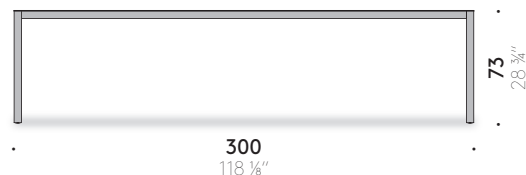
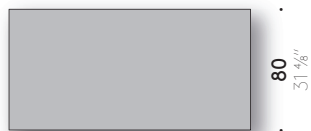
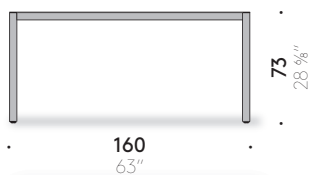
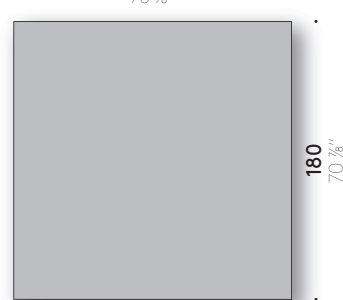
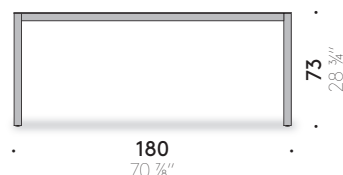
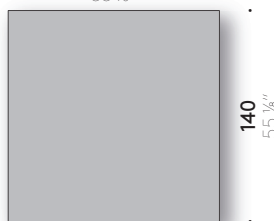
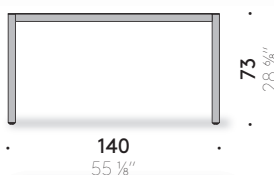

Shadow

Vincent Van Duysen

2011



Table

Materials

INTERIOR FRAME: powder-coated steel.
 BASE/TOP: bicolour finish. Top and exterior sides of the legs in layered HPL laminate veneered in Ecowood Xilo 2.0 planked grey (18.23), finished with transparent water-based or solvent-based coating. Interior sides of the legs and top undersides in layered HPL laminate veneered in Ecowood Xilo 2.0 planked sand (18.22), finished with transparent water-based or solvent-based coating.
 FEET: adjustable, in thermoplastic material.

+info:
<http://www.depadova.com/materials.pdf>

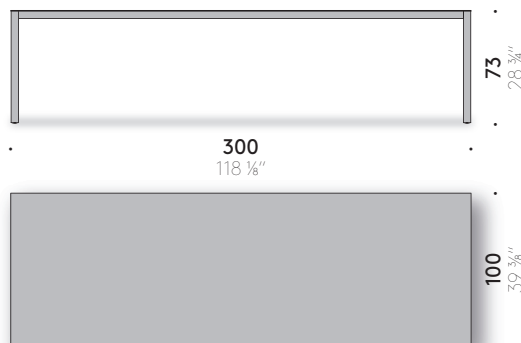
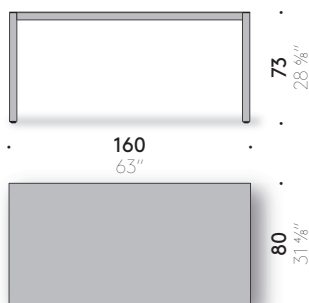
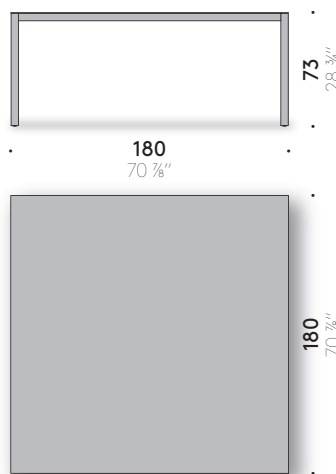
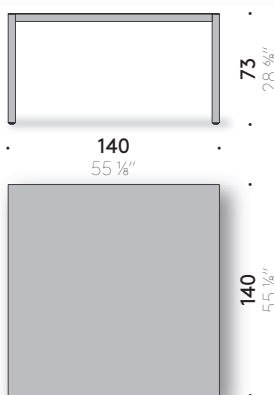

Shadow

Vincent Van Duysen

2011



Table

Matériaux

STRUCTURE INTERNE: acier peint à poudre.
 BASE/DESSUS: finition bicolore. Dessus et côtés externes des piètements en mélaminé HPL stratifié plaqué en bois Ecowood Xilo 2.0 planked grey (18.23), fini avec peinture transparente à base d'eau ou à base de solvant. Côtés internes des piètements et bandes sous plan en mélaminé HPL stratifié plaqué en bois Ecowood Xilo 2.0 planked sand (18.22), fini avec peinture transparente à base d'eau ou à base de solvant.
 PIEDS: réglables en thermoplastique.

+info:
<http://www.depadova.com/materials.pdf>

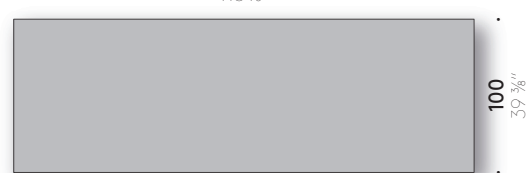
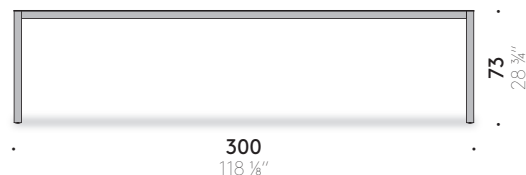
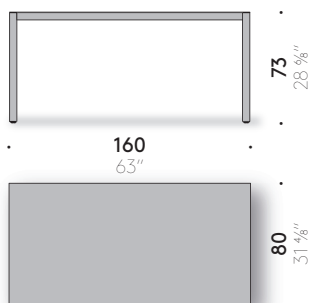
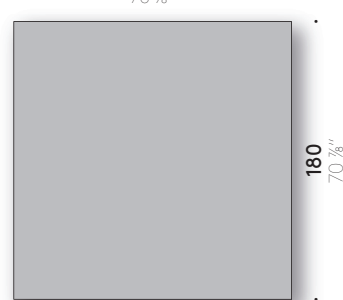
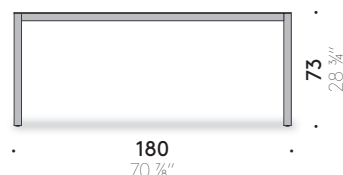
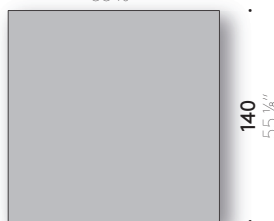
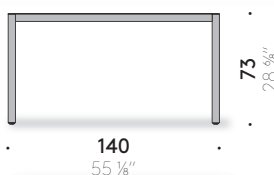

Shadow

Vincent Van Duysen

2011

Tisch

Materialien

INNENGESTELL: stahl mit Pulverlackierung.
 UNTERGESTELL/TISCHPLATTE: zweifarbige Ausführung. Tischplatte und Außenseiten der Beine aus Schichtlaminat HPL, furniert in Ecowood Xilo 2.0 Planked Grey (18.23), endbehandelt mit transparentem Lack auf Wasser- oder Lösemittelbasis. Innenseite der Beine und horizontale Blenden aus HPL-Schichtlaminat furniert in Ecowood Xilo 2.0 Planked Sand (18.22), endbehandelt mit transparentem Lack auf Wasser- oder Lösemittelbasis.
 FÜSSE: Verstellbare Thermoplast-Füße.

+info:
<http://www.depadova.com/materials.pdf>

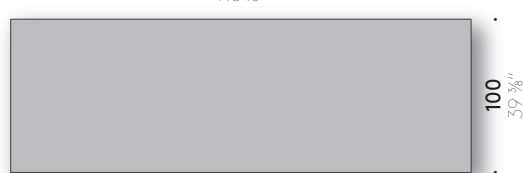
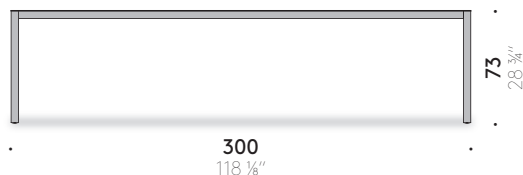
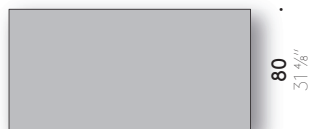
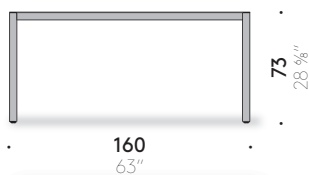
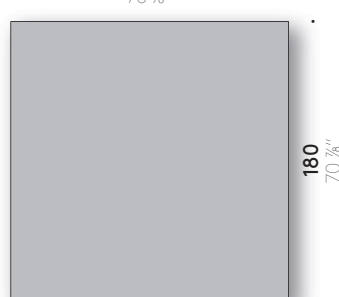
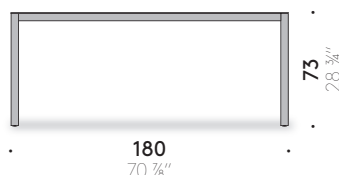
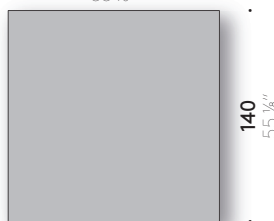
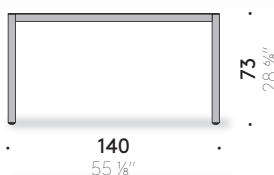

Shadow

Vincent Van Duysen

2011

Mesa

Materiales

ESTRUCTURA INTERIOR: acero pintado en polvo.
 BASE/TABLERO: acabado bicolor. Tablero y caras exteriores de las patas en laminado HPL estratificado chapado en madera Ecowood Xilo 2.0 planked grey (18.23), acabado con barniz transparente al agua o al disolvente. Caras interiores de las patas y fajas debajo del tablero en laminado HPL estratificado chapado en madera Ecowood Xilo 2.0 planked sand (18.22), acabado con pintura transparente al agua o al disolvente.
 PIES: ajustables de material termoplástico.

+info:
<http://www.depadova.com/materials.pdf>

