

# Mawari

Design:  
GUNTHER PELGRIMS



+ info: <https://www.depadova.com/materials.pdf>  
De Padova srl - info@depadova.it

## TABLE

### Materials

#### Base

solid natural oak with decorating inserts in wengé with interior supports in steel, finished with transparent water-based or solvent-based coating.

#### Top

solid wood layers in natural oak with decorating inserts in wengé, finished with transparent water-based or solvent-based coating.

#### Tray

(optional)

solid natural oak with decorating inserts in wengé, finished with transparent water-based or solvent-based coating.

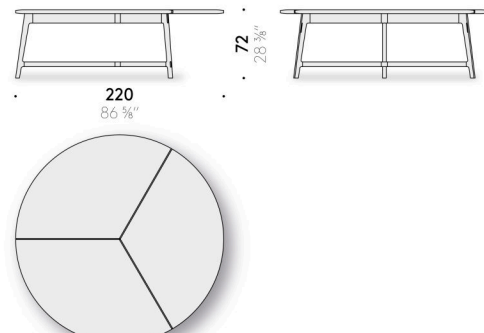
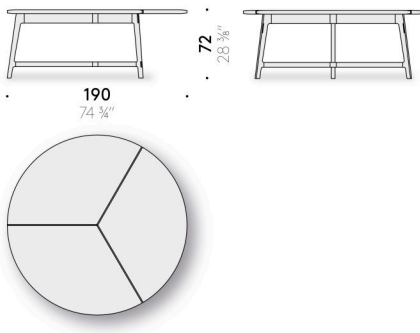

# Mawari

Design:  
GUNTHER PELGRIMS



+ info: <https://www.depadova.com/materials.pdf>  
De Padova srl - info@depadova.it

## TAVOLO

### Materiali

#### Base

massello di rovere naturale con inserti wengè con rinforzi interni in acciaio, finito con vernice trasparente a base acqua o a base solvente.

#### Piano

piano stratificato in cartelle di legno massello in rovere naturale con inserti wengè finito con vernice trasparente a base acqua o a base solvente.

#### Vassoio

(opzionale)

massello di rovere naturale con inserti wengè, finito con vernice trasparente a base acqua o a base solvente.

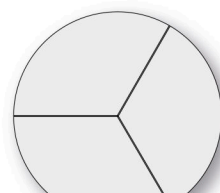
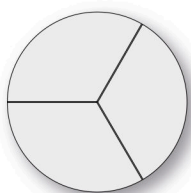
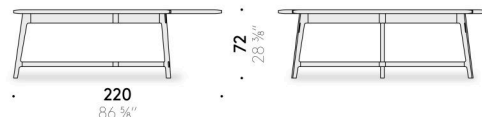
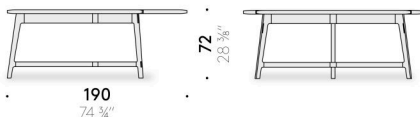

# Mawari

Design:  
GUNTHER PELGRIMS



+ info: <https://www.depadova.com/materials.pdf>  
De Padova srl - info@depadova.it

## TABLE

### Matériaux

#### Base

massif de chêne naturel avec inserts wengé avec renforts internes en acier,  
fini avec peinture transparente à l'eau ou à base de solvant.

#### Dessus

dessus stratifié en lattes de bois massif en chêne naturel avec inserts wengé  
fini avec peinture transparente à l'eau ou à base de solvant.

#### Plateau

(optionnel)

massif de chêne naturel avec inserts wengé, fini avec peinture transparent à  
l'eau ou à base de solvant.

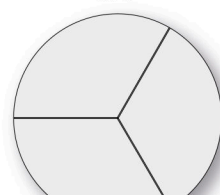
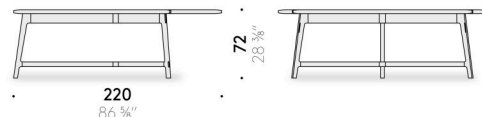
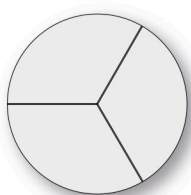
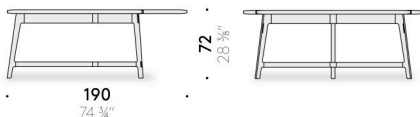

# Mawari

Design:  
GUNTHER PELGRIMS



+ info: <https://www.depadova.com/materials.pdf>  
De Padova srl - info@depadova.it

## TISCH

### Materialien

#### Gestell

Massive Natureiche mit Einsätzen aus Wenge-Vollholz, mit innenliegenden Stahlverstärkungen, endbehandelt mit transparentem Lack auf Wasser- oder Lösemittelbasis.

#### Tischplatte

Schichtholz-Tischplatte mit Massivholz Furnieren in Natureiche, mit Einsätzen aus Wenge, endbehandelt mit transparentem Lack auf Wasser- oder Lösemittelbasis.

#### Tablett

(optional)

Massive Natureiche mit Einsätzen in Wenge, endbehandelt mit transparentem Lack auf Wasser- oder Lösemittelbasis.

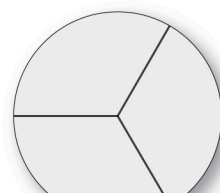
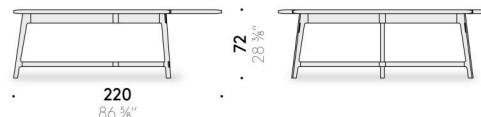
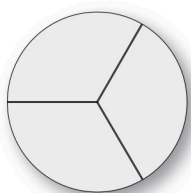
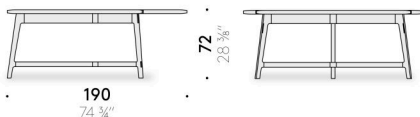

# Mawari

Design:  
GUNTHER PELGRIMS



+ info: <https://www.depadova.com/materials.pdf>  
De Padova srl - info@depadova.it

## MESA

### Materiales

#### Base

madera de roble natural con inserciones wengé con refuerzos interiores de acero, acabado con barniz transparente al agua o al disolvente.

#### Tablero

tablero estratificado de hojas de madera maciza de roble natural con inserciones wengé acabado con barniz transparente al agua o al disolvente..

#### Bandeja

(opcional)

madera maciza de roble natural con inserciones wengé, acabada con barniz transparente al agua o al disolvente.

