

# The Sensitive Light Chair

Design:

TIME & STYLE ědition  
MADE IN JAPAN

TIME & STYLE ědition

+ info: <https://www.depadova.com/materials.pdf>  
De Padova srl - info@depadova.it



## CHAIR

### Materials

#### Frame

snow white or grey charcoal-stained solid beech, finished with transparent water-based or solvent-based coating.

#### Upholstered seat

elastic fabric panel, padded with polyurethane foam. For the FR (Fire Resistant) versions on request, the filling materials comply with the current regulations.

#### Cover

non-removable cover in grey fabric or dark brown leather.

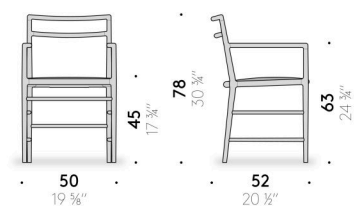
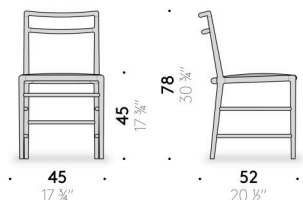

# The Sensitive Light Chair

Design:

TIME & STYLE ědition  
MADE IN JAPAN

TIME & STYLE ědition

+ info: <https://www.depadova.com/materials.pdf>  
De Padova srl - info@depadova.it



## SEDIA

### Materiali

#### Struttura

massello di faggio tinto bianco neve o grigio carbone, finito con vernice trasparente a base acqua o a solvente.

#### Seduta imbottita

pannello di tessuto elastico, imbottito in poliuretano espanso. Per le versioni FR (Fire Resistant) a richiesta, i materiali dell'imbottitura sono come da normativa.

#### Rivestimento

rivestimento fisso in tessuto grigio o pelle marrone scuro.

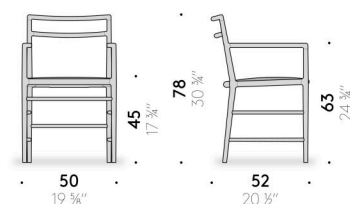
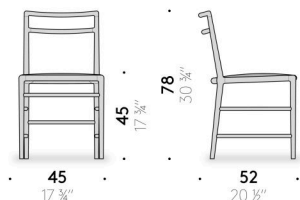

# The Sensitive Light Chair

Design:

TIME & STYLE édition  
MADE IN JAPAN

TIME & STYLE édition

+ info: <https://www.depadova.com/materials.pdf>  
De Padova srl - info@depadova.it



## CHAISE

### Matériaux

#### Structure

massif de hêtre teinté blanc neige ou gris charbon, fini avec peinture transparente à l'eau ou au solvant.

#### Assise rembourrée

panneau en tissu élastique, rembourré de mousse de polyuréthane. Pour les versions FR (Fire Resistant) sur demande, les matériaux de rembourrage sont conformes à la réglementation en vigueur.

#### Revêtement

revêtement fixe en tissu gris ou cuir marron foncé.

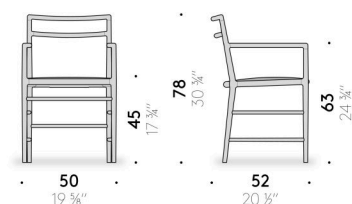
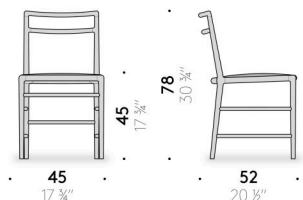

# The Sensitive Light Chair

Design:

TIME & STYLE édition  
MADE IN JAPAN

TIME & STYLE édition

+ info: <https://www.depadova.com/materials.pdf>  
De Padova srl - info@depadova.it



## STUHL

### Materialien

Gestell

Massivbuchenholz, Schneeweiß oder kohlegrau gefärbt, endbehandelt mit transparentem Lack auf Wasser- oder Lösemittelbasis.

Gepolsterte Sitzfläche

elastisches Gewebepaneel, gepolstert mit Polyurethanschaum. Bei den FR-Versionen (Fire Resistant), die auf Anfrage erhältlich sind, entsprechen die Polstermaterialien den geltenden Bestimmungen.

Bezug

fester Stoffbezug grau oder Lederbezug, dunkelbraun.

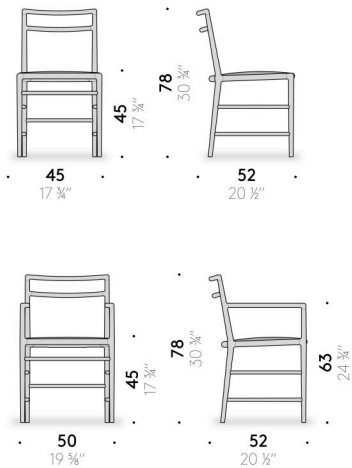

# The Sensitive Light Chair

Design:

TIME & STYLE édition  
MADE IN JAPAN

TIME & STYLE édition

+ info: <https://www.depadova.com/materials.pdf>  
De Padova srl - info@depadova.it



## SILLA

### Materiales

#### Estructura

madera maciza de haya teñida blanco nieve o gris carbón, acabada con barniz transparente al agua o al disolvente.

#### Asiento acolchado

panel de tejido elástico, relleno de espuma de poliuretano. Para las versiones FR (Fire Resistant) bajo pedido, los materiales del relleno cumplen con la normativa.

#### Revestimiento

revestimiento fijo de tejido gris o piel marrón oscuro.

